

Chicago Plastic Systems 90 Degree 3 Gore Elbow

Elbows 6" through 24" are fabricated from extruded PVC duct pipe. The socket dimension is approximate.

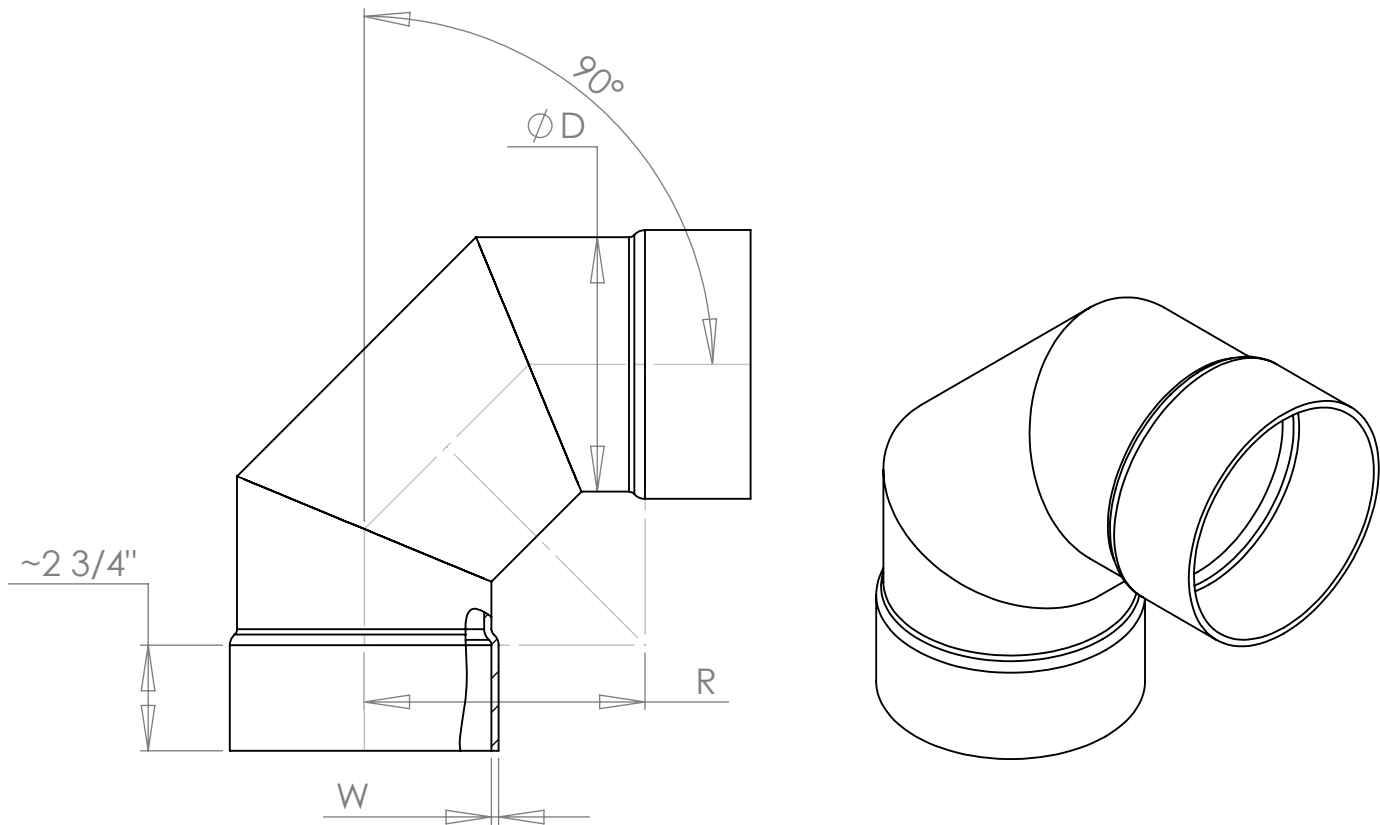

Duct Size	R	D	W	Throat Radius
6in	7.313	6.625	0.1875	4.000
7in	8.354	7.375	0.1875	4.667
8in	9.646	8.625	0.1875	5.333
9in	10.688	9.375	0.1875	6.000
10in	12.042	10.75	0.1875	6.667
11in	13.021	11.375	0.1875	7.333
12in	14.375	12.75	0.1875	8.000
14in	16.333	14	0.1875	9.333
16in	18.667	16	0.1875	10.667
18in	21.000	18	0.1875	12.000
20in	23.333	20	0.22	13.333
24in	28.000	24	0.25	16.000

PVC Classes 12454-B&C per ASTM D-1784-92
(Formerly known as Type I, Grades 1&2)